

Firma Eder (www.eder.com.pl) w swojej ofercie posiada:

- węże i sznury
- uszczelki według wzoru Klienta
- uszczelki typowe do wszelkich zastosowań
- wyroby z silikonu gąbczastego
- wyroby o podwyższonej odporności termicznej

Dysponujemy nowoczesnym parkiem maszynowym oraz własnym zapleczem technicznym, co pozwala w możliwie najkrótszym czasie wykonać niezbędne narzędzia do produkcji.

Naszym Klientom oferujemy wyroby z surowca najwyższej jakości o następujących własnościach:

- twardość - $15 \div 80^\circ$ Sh A
- kolor - według palety RAL, z załączonego wzornika
- odporność termiczna - standardowa 250°C , podwyższona 315°C

Minimalna ilość zamówienia wynosi 30mb, choć możliwe jest wynegocjowanie mniejszej partii. Jakość produktu jest kontrolowana w sposób ciągły, a dopuszczalne odchyłki wymiarów są zgodne z normą PN-66/C-94126 w klasie 3 lub 5.

Standardowe kolory wyrobów

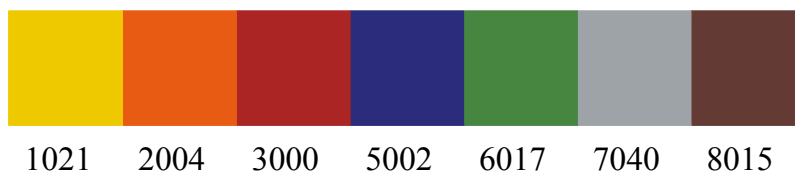

a także naturalny (bezbarwny, półprzezroczysty), czarny 9005, srebrny 9006 i biały 9010.

Katalog został uporządkowany według możliwych zastosowań uszczelek oraz ich podobieństwa.

profile typu "e"

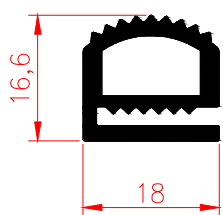

1009

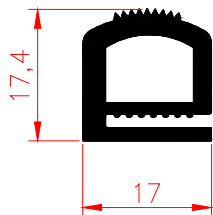

1010

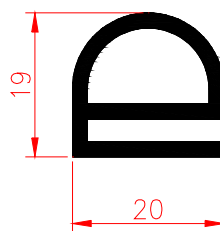

1018

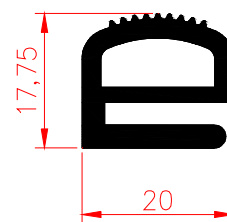

1023

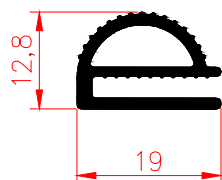

1032

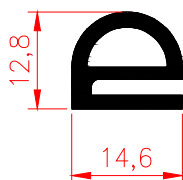

1037

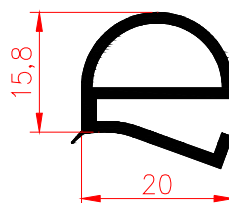

1054

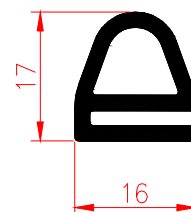

1071

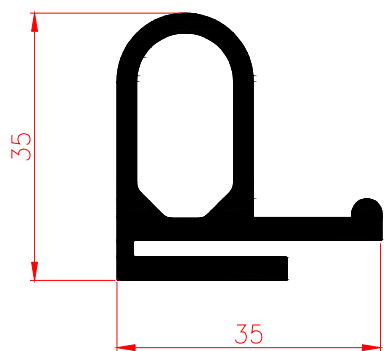

1123

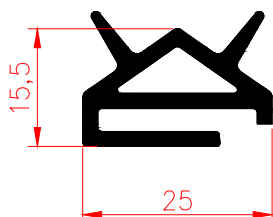

1161

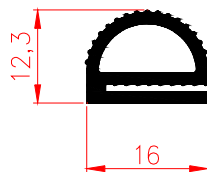

1194

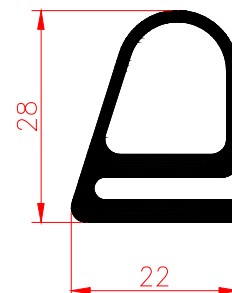

3148

profile typu "p"

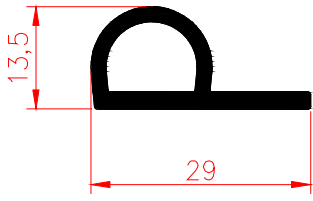

1008

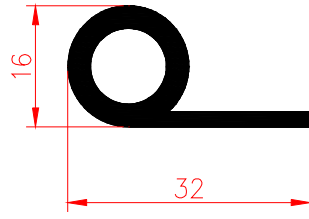

1019

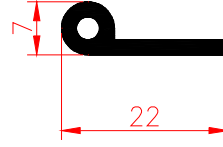

1044

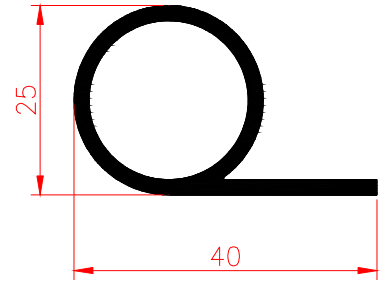

1124

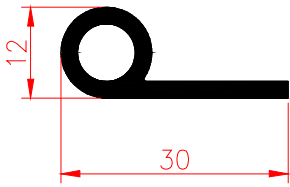

1116

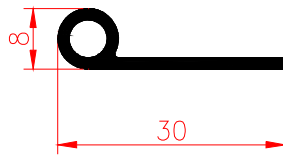

3013/1

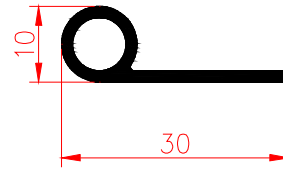

3013/3

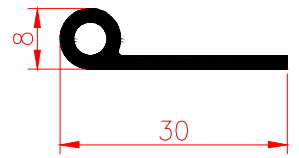

3013/4

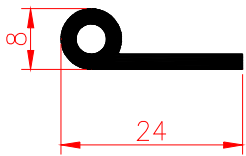

3013/6

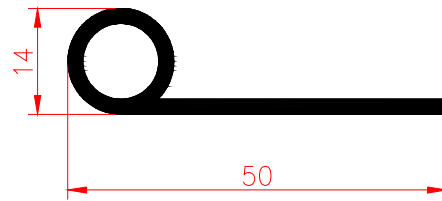

3013/7

profile typu "u"

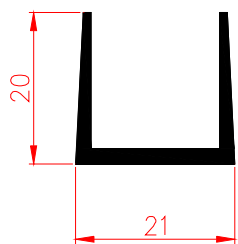

1017

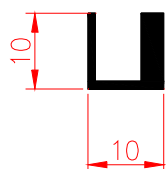

1055

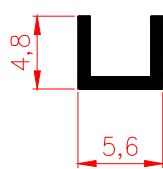

1057

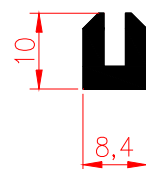

1062

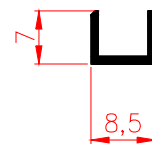

1062/1

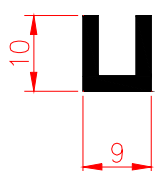

1073

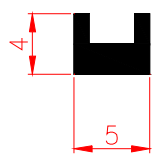

1098

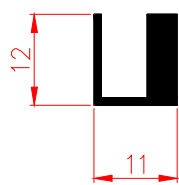

1136

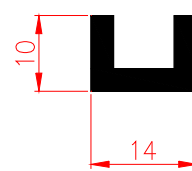

1137

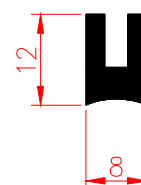

1142

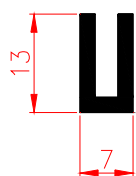

1146

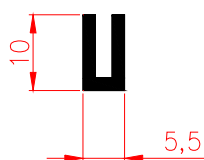

1187

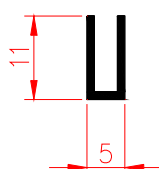

3029/1

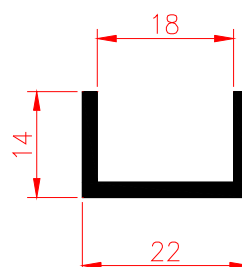

3029/6

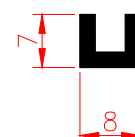

3029/7

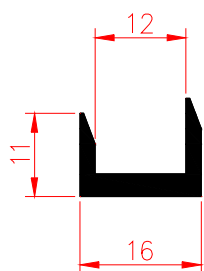

3025

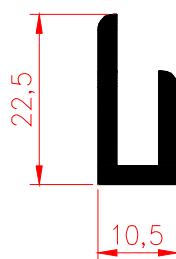

441

profile typu "u"

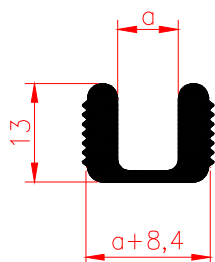

1024/a

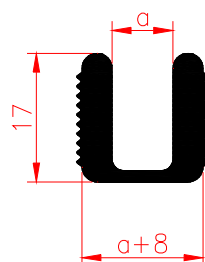

1025/a

$a = 8, 10, 12, 15, 19, 22, 26, 40\text{mm}$

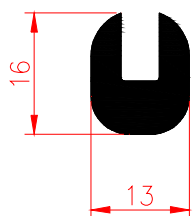

1090

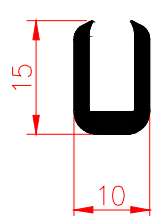

1107

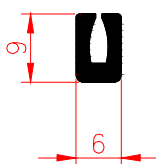

1108

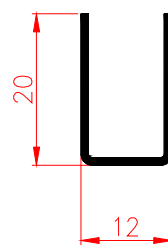

1117

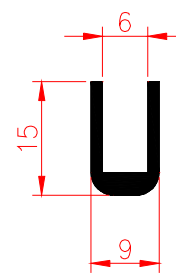

232

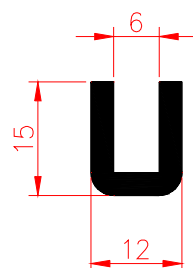

232/1

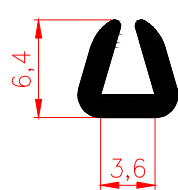

235

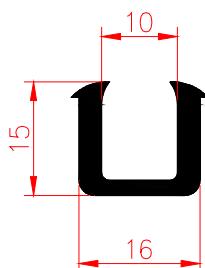

411

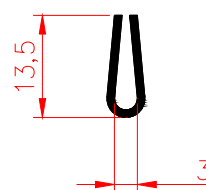

1050

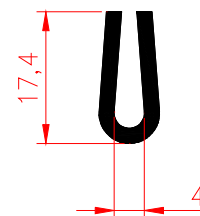

1053

uszczelnienia drzwi

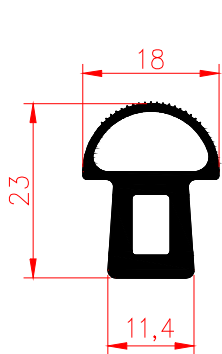

1013

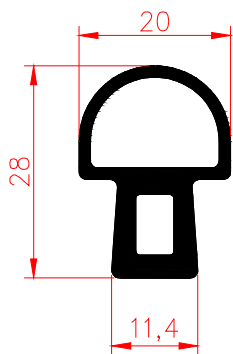

1014

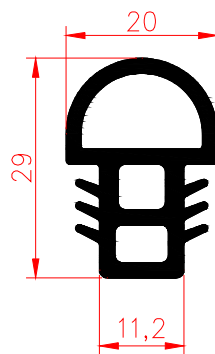

1056

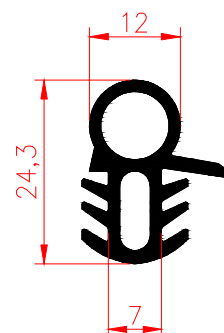

1058

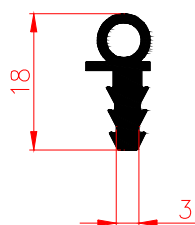

1128

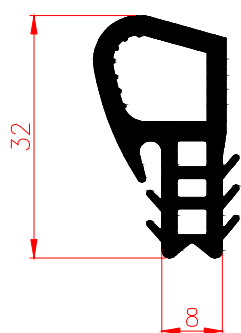

1156

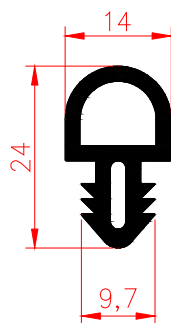

1157

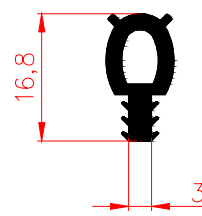

1168

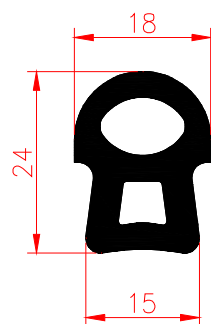

1172

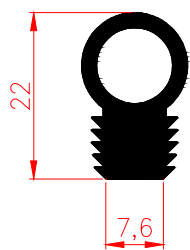

1197

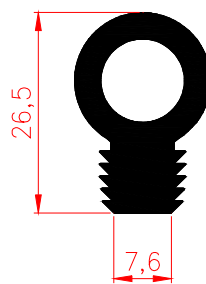

1197/1

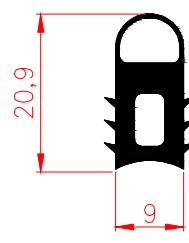

1203

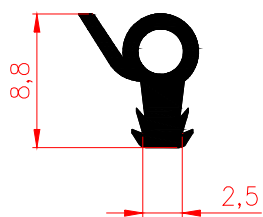

178

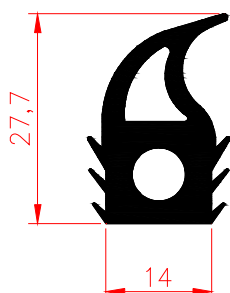

1012

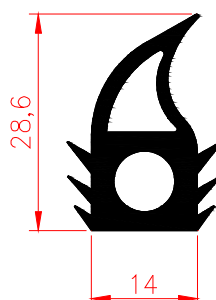

1063

uszczelnienia drzwi

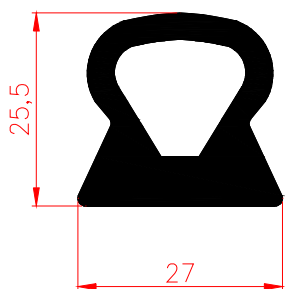

1003/1

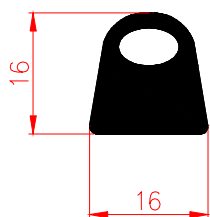

1020

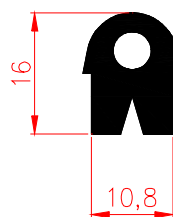

1039

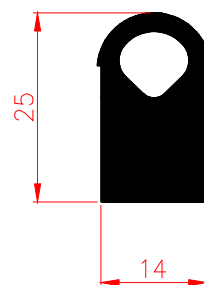

1084

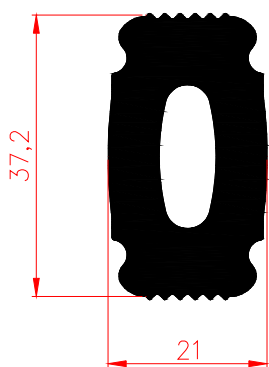

1154

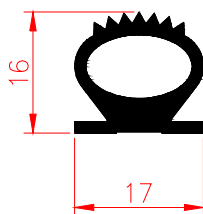

1002

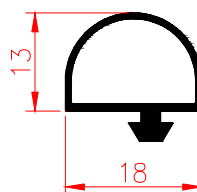

1030

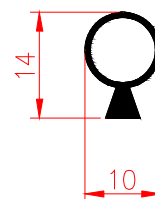

1031

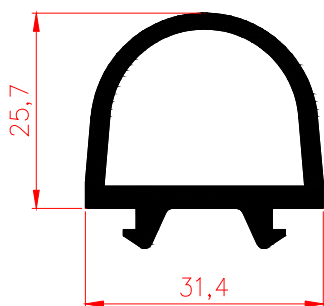

1040

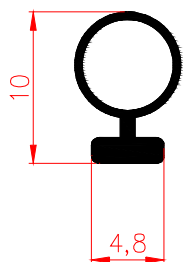

1049

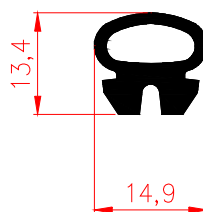

141

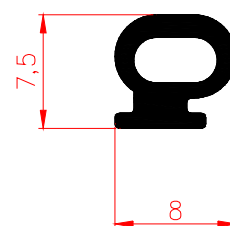

151/1

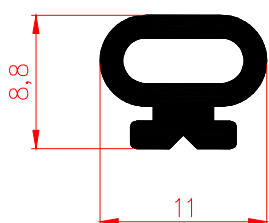

155

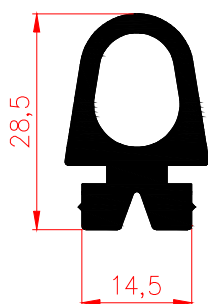

165

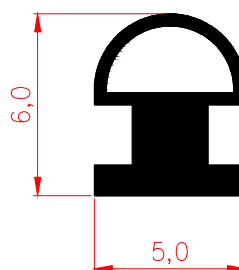

167

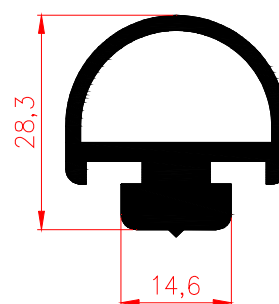

181

uszczelnienia drzwi

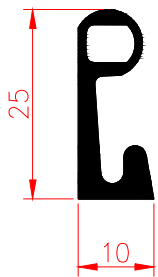

1127

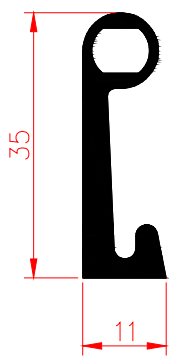

1069

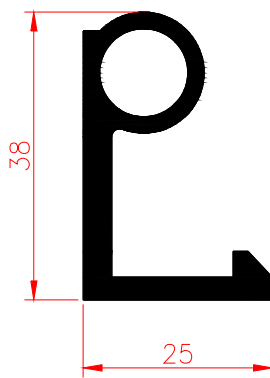

1048

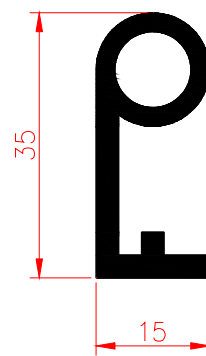

1015

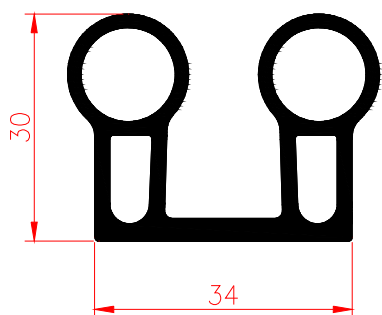

1064

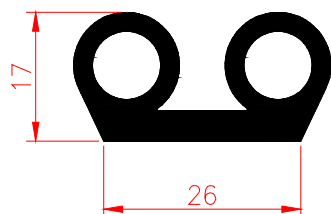

1076

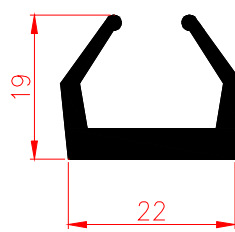

1094

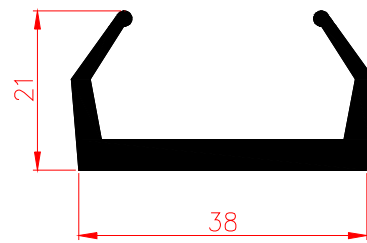

1094/1

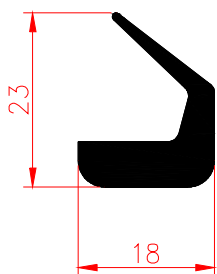

1022

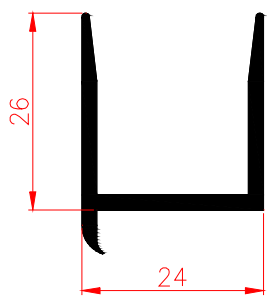

1029

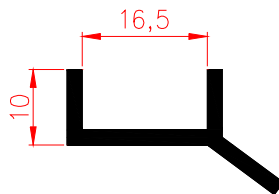

1035

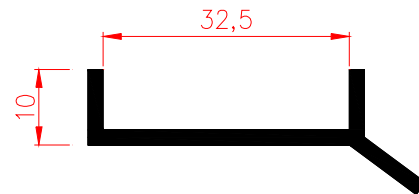

1036

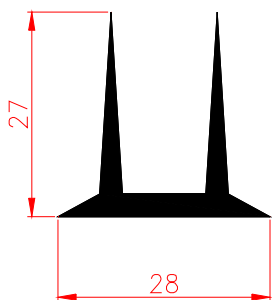

1099

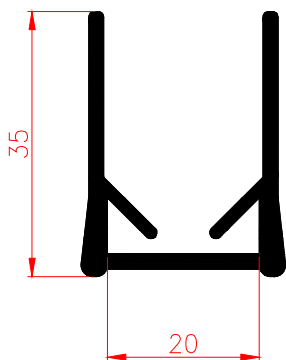

1160

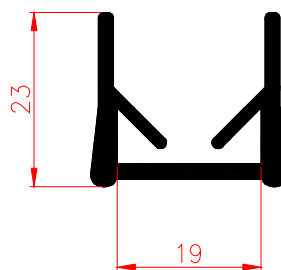

1160/1

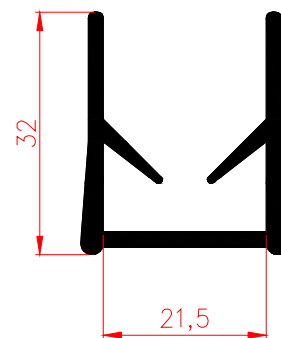

1160/3

uszczelki przyszybowe

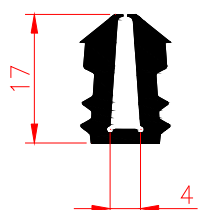

1006

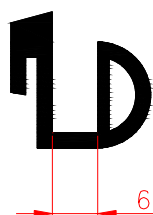

1042

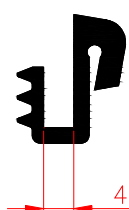

1131

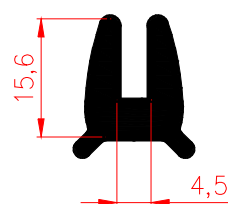

1188

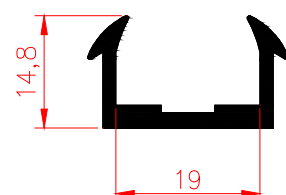

175

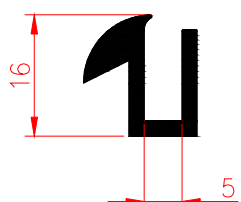

224

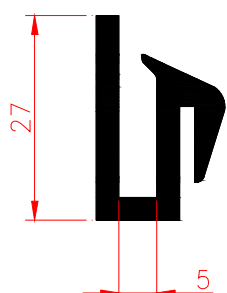

3038

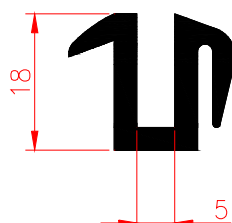

3050

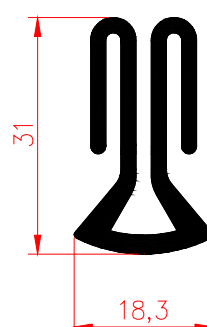

3072

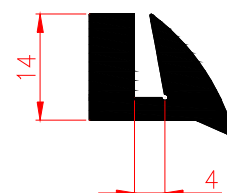

3171

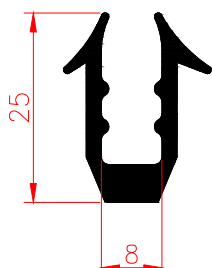

504

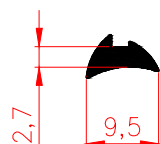

1041

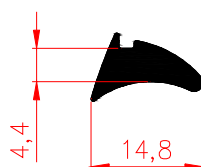

174

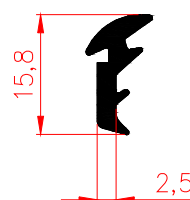

157

ramy okien

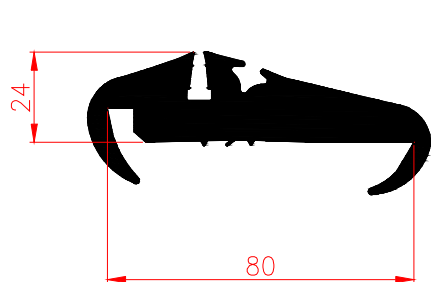

160/1

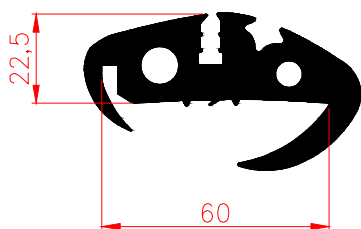

162/1

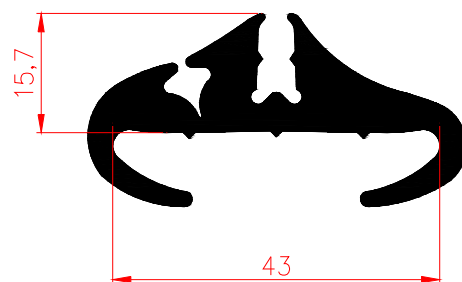

1081

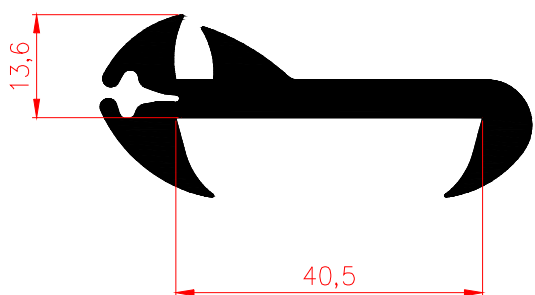

1169

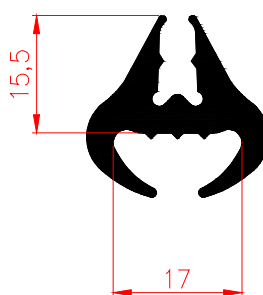

1080

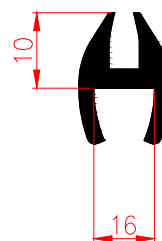

1129

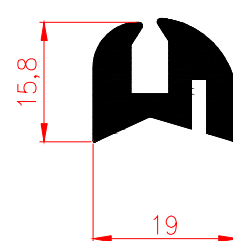

217/1

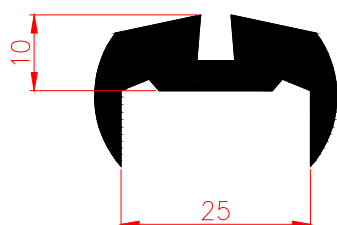

222

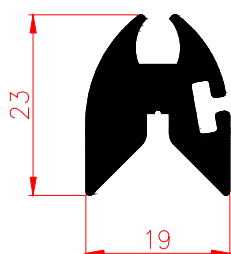

3045

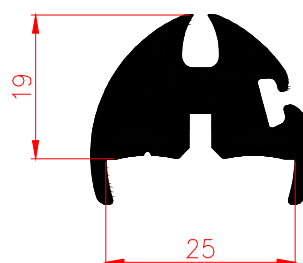

3059

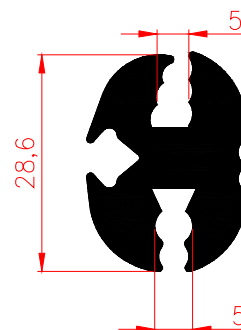

205

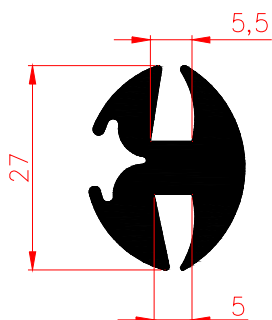

3103

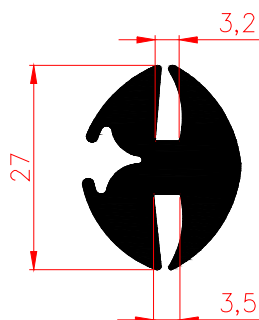

3104

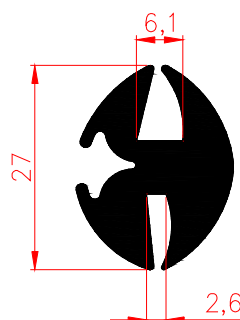

3105

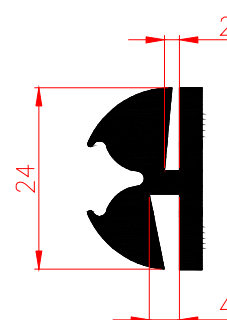

404

kliny rozprężne

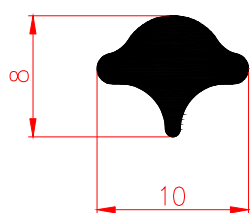

1170

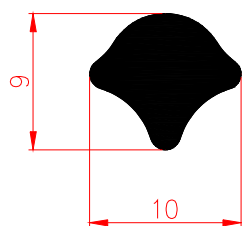

3043/1

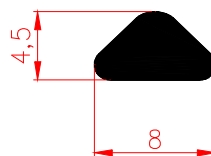

3044a

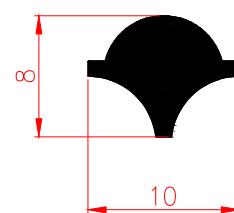

3106

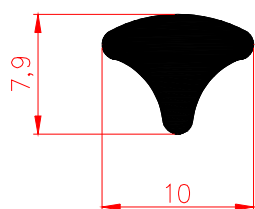

403

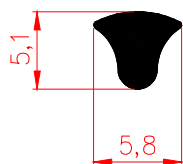

604

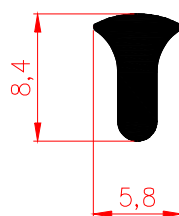

604/1

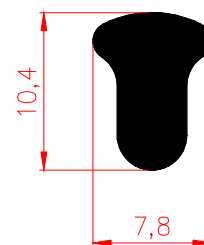

604/2

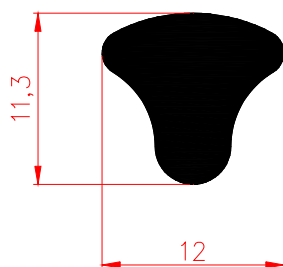

604/3

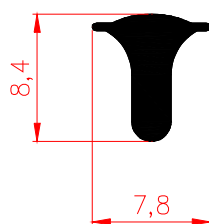

604/4

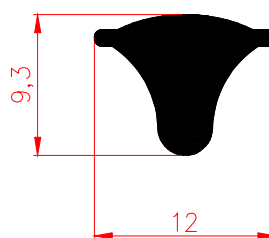

604/5

uszczelki maskujące

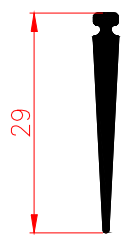

1115/2

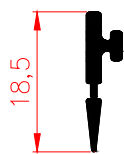

1115/3

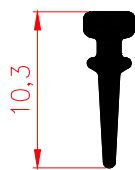

1115/4

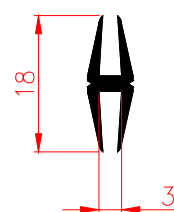

1130

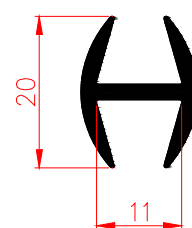

1132

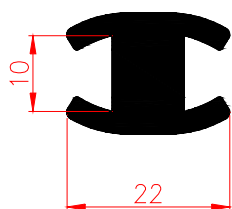

1158

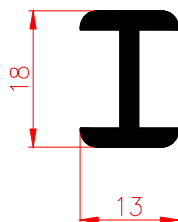

1164

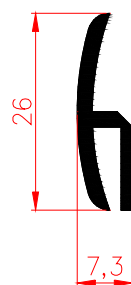

1190

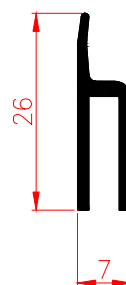

230

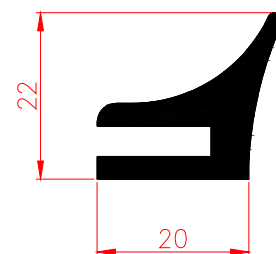

416

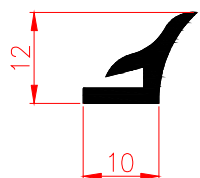

440

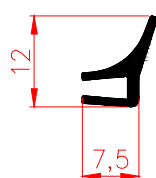

503

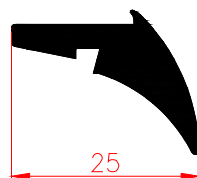

405

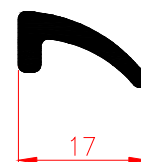

432

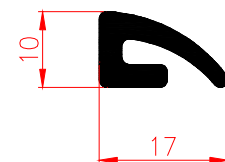

432/1

zaślepienia

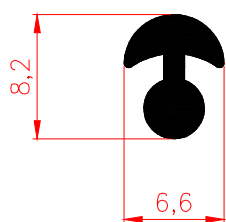

1052

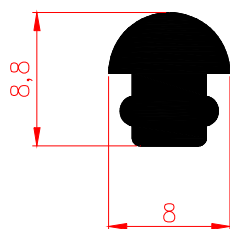

1065

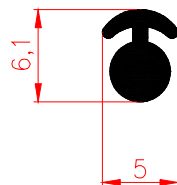

1078

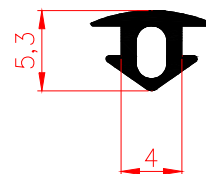

1115

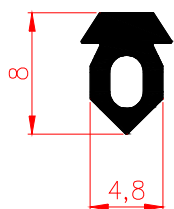

1199

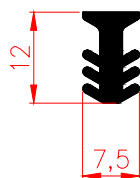

1138

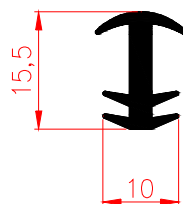

1174

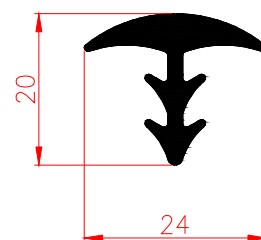

415

sznury okrągłe, prostokątne i węże

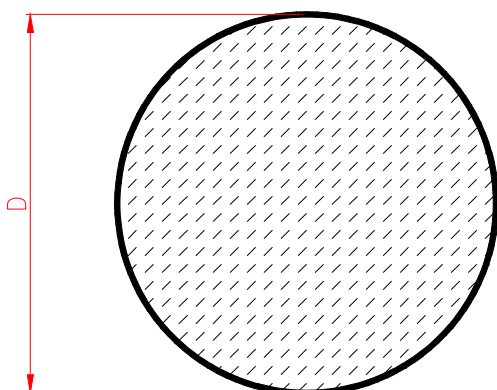

Oznaczenie:

PK-D (silikon lity)

SPK-D (silikon porowaty)

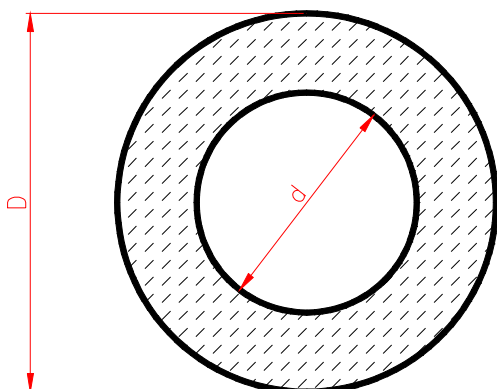

Oznaczenie:

PR-D/d (silikon lity)

SPR-D/d (silikon porowaty)

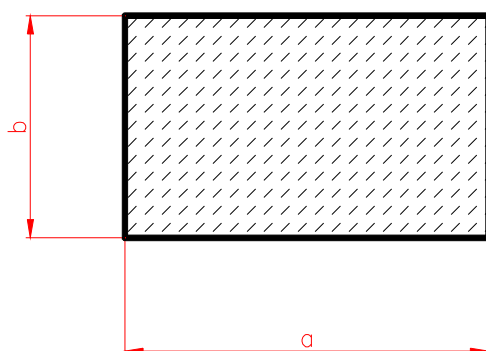

Oznaczenie:

PP-a/b (silikon lity)

SPP-a/b (silikon porowaty)